

BIODEVICES 2008

International Conference on
Biomedical Electronics and Devices

Proceedings

Volume 2

Funchal, Madeira - Portugal · 28 - 31 January, 2008

TECHNICAL CO-SPONSORSHIP BY



CO-ORGANIZED BY



IN COOPERATION WITH



BIODEVICES 2008

Proceedings of the
First International Conference on
Biomedical Electronics and Devices

Volume 2

Funchal, Madeira - Portugal

January 28 – 31, 2008

Co-organized by
**INSTICC – Institute for Systems and Technologies of Information,
Control and Communication**
and
UMA – University of Madeira

Technical Co-sponsorship by
IEEE EMB – Engineering in Medicine and Biology Society

In Cooperation with
AAAI – Association for the Advancement of Artificial Intelligence

INSTRUMENTED SPLINT FOR THE DIAGNOSIS OF BRUXISM

Pilar Lafont Morgado, Andrés Díaz Lantada, Alexander Martínez Álvarez, Antonio Barrientos Cruz
Héctor Lorenzo-Yustos, Pedro Luis Castedo Cepeda, Roberto González Herranz
Julio Muñoz García and Javier Echavarrri Otero
Universidad Politécnica de Madrid
C/ José Gutiérrez Abascal, nº 2. 28006 – Madrid, Spain (+34) 913364217
adiaz@etsii.upm.es

Keywords: Telemedicine, Electroactive Polymers (EAPs), Biomaterials, Bruxism, Temporomandibular Joint.

Abstract: Bruxism is a health problem consisting in grinding or tightly clenching the upper and lower teeth. Both the grinding and sliding lead to wear of the teeth and produce a noise during the night that is sufficiently loud to disturb the sleep of anyone sharing the bedroom. The tension produced causes problems in the muscles, tissues and other structures surrounding the jaw, ear pain, headaches, lesions to the teeth and disorders in the jaw joints.

For an early, rapid, effective and economical diagnosis of bruxism, we propose the use of instrumented splints to detect and record the intensity and duration of interdental pressure episodes. This paper sets out the design, manufacture and testing of an instrumented splint for diagnosing the signs of bruxism.

The system stands out for its use of piezoelectric polymeric sensors which, because of their reduced thickness, do not cause any alteration to the patient's bite. It lets a quantitative assessment of intraoral pressure be made and bruxism behaviour be diagnosed at an early stage, so as to being able to programme corrective actions before irreversible dental wear appears. The first "in vitro" simulations and "in vivo" trials performed served to demonstrate the feasibility of the system in accordance with the initial objectives.

1 BRUXISM: CHARACTERISTICS AND PREVALENCE

Bruxism is a health problem consisting in grinding or tightly clenching the upper and lower teeth. Both the grinding and sliding lead to wear of the teeth and produce a noise during the night that is sufficiently loud to disturb the sleep of anyone sharing the bedroom. The tension produced causes problems in the muscles, tissues and other structures surrounding the jaw, ear pain, headaches, lesions to the teeth and disorders in the jaw joints. All these symptoms as a whole are usually described as temporomandibular joint problems (TMJ) or also as Craniomandibular Dysfunction Pain Syndrome.

The phenomenon was introduced to dental literature as bruxomania by Marie and Pietkiewkz in 1907. They described the habit of grinding the teeth. The term bruxism was introduced by Frohman in 1931. In 1936 Miller proposed using the term bruxomania for daytime grinding and bruxism for night time grinding. The terms traumatic neuralgia,

the Karolyi effect and occlusive habit neurosis have all been used to refer to some form of teeth grinding or clenching.

According to a study by the Canadian Sleep Society nocturnal bruxism affects 8% of the adult population and 14% of the child population. A decrease in the population affected can be appreciated with age, attaining 3% for people over 60. However, for researchers like Melis and Granada prevalence is around 25%.

As to differences by sex there is no general agreement since there are publications that describe a greater bruxism activity in men (Quirch, Ozaki), others in women (Barreto, De los Santos) while others deem it to be an insignificant factor (Hayden, Kononean).

To summarise Nishigawa's study on the bite force produced during bruxism episodes, this can frequently reach 1100 N exceeding the maximal voluntary bite force. Pressures reached on the teeth surface can reach 40 MPa, high enough to cause high levels of wear and even breakages.

As to the duration of bruxism episodes, an average time of around 7 seconds has been found and when developing sensors it is necessary to

distinguish bruxism episodes from mioclonus or rapid contractions (< 0.5 s) of the jaw muscles.

However, it is important to point out that everybody subconsciously clenches their teeth at some time of the day and this could be considered as bruxism activity. The term bruxism is only used though when the duration and intensity of this activity has a bearing on dental wear and the appearance of TMJ problems.

One of the main problems associated with the traditional diagnosis of bruxism is that it is frequently made when the teeth are already highly worn and the prognosis of the illness is more severe. Bruxism activity can also be recorded by an EEG (electroencephalogram) as well as by EMG (electromyography) and S-EMG (surface electromyography). In many cases video-cameras are used in the study to distinguish the bruxism episodes of the mioclonus or rapid contractions (< 0.5 s) of the jaw muscles.

However, in order to be able to make an earlier, more rapid, more effective and economical diagnosis of bruxism, the research team that have written this paper propose using instrumented splints for detecting and recording the intensity and duration of interdental pressure episodes. Explained below are the design, manufacture and trials of an instrumented splint for the diagnosis of bruxism activity. It has been developed by researchers at Universidad Politécnica de Madrid in collaboration with Ibex Estética Dental S.L..

2 DESIGN OF THE DEVICE FOR DIAGNOSING BRUXISM USING ELECTROACTIVE POLYMERS AS SENSORS

Traditionally discharge splints or protection devices are used to treat bruxism and prevent the associated dental wear. As a diagnostic device we propose introducing pressure sensors into a splint so that patients' bite episodes can be recorded and the extent of their pathology be assessed. Piezoelectric polymers are used as pressure sensors for the reasons set out below.

Piezoelectric Electroactive Polymers as Pressure Transducers: PVDF (Polyvinylidene Fluoride)

Piezoelectricity was discovered in 1880 by Pierre and Paul-Jaques Curie, who observed that when certain crystals were compressed, like quartz or tourmaline, depending on certain directions they produced a voltage between zones on their surface.

When force was applied the relative positions of the crystal molecules changed producing an internal displacement of charges which was the cause of this voltage.

These crystals also underwent the inverse effect since they became deformed when a voltage difference was applied. This property is found in materials lacking a centre of symmetry and the phenomenon is called ferroelectricity when a non-conductor crystal or dielectric material exhibits spontaneous electric polarisation.

Polyvinylidene fluoride or PVDF $-(CH_2-CF_2)_n$ and its co-polymers such as poly(vinylidene fluoride-trifluoroethylene) or P(VDF-TrFE), are the polymers of this kind with the largest number of industrial applications. They possess partial crystallinity with an inactive amorphous phase and an elastic modulus close to between 1 and 10 GPa. Their use as actuators is limited by the need to apply high electric fields (around 20 V/ μ m for a 3% deformation), but their use as pressure sensors is taking the place of traditionally used piezoelectric ceramic materials.

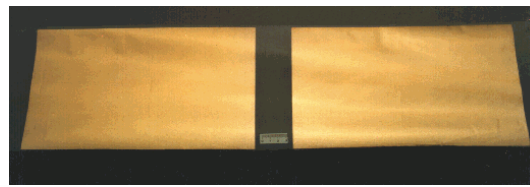

Figure 1: Metallized PVDF sheets. Piezotech S.A..

The use of this type of sensor was considered because of its reduced thickness, which does not cause any alteration to the patient's bite and because of its greater resistance and sensitivity compared to ceramic piezoelectrics. To make the sensors, we took PVDF 40 μ m thick sheets from Piezotech S.A. with Au-Pt coated electrodes. These sheets were cut, joined to the connecting wires and suitably encapsulated to protect them and be inserted into the splint (see manufacturing process). The sensors obtained are shown below, together with the behaviour model allowing them to be simulated and the first results obtained in the trials carried out.

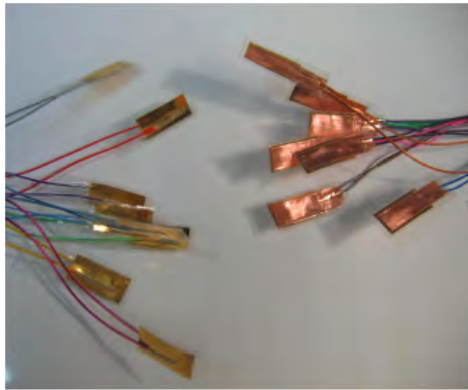

Figure 2: Piezoelectric sensors manufactured. Product Development Laboratory. Universidad Politécnica de Madrid.

Figure 3: a) shows the piezoelectric sensor layout. The charge displacement produced when a force is applied to the piezoelectric sensor can be represented using the equivalent electric circuit depicted in Figure 3 b).

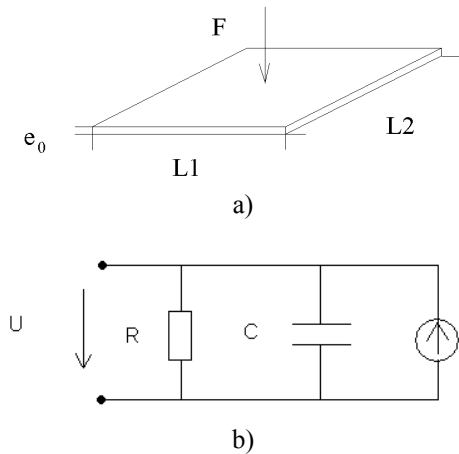

Figure 3: a) Piezoelectric Sensor. b) Electrical behaviour circuit diagram of the piezoelectric sensor.

Force F on the sensor acts as a generator of intensity powering a C capacity condenser. Ec (1).

$$C = C(F) = \epsilon \cdot (L1 \cdot L2) / e \quad (1)$$

Where:

- ϵ .- The dielectric constant of the sensor.
- $L1 \cdot L2$.- The effective area of the sensor.
- e .- The thickness of the sensor.

The thickness of the sensor, e, depends on the initial thickness, e_0 , on the pressure applied, $\sigma = F / (L1 \cdot L2)$, and the Young modulus of the material, E, using the following expression Eq. (2):

$$e = e_0 \cdot (1 - \sigma / E) \quad (2)$$

Current intensity, I, generated by applying force F, depends on the transversal piezoelectric coefficient of sensor d33 according to Eq. (3).

$$Q = d33 \cdot F \rightarrow I = dQ / dt = d33 \cdot dF / dt \quad (3)$$

When the sensor is connected to an external circuit, as is shown in Figure 3 b), it discharges in accordance with the equivalent R resistance of this external circuit (the oscilloscope input resistance in the first trials carried out). The intensity is given by Eq. (4).

$$I = d33 \cdot dF / dt = U / R + C \cdot dU / dt \quad (4)$$

With the above equations and previous data a model was made in Simulink which permits a rapid assessment of the effect of modifying the parameters. The model and the results of the simulation are shown below, together with the first real trials carried out with the piezoelectric sensor connected directly to the oscilloscope when it was subjected to levels of pressure.

For the first simulations and trials with the sensors manufactured (Figures 5, 6 and 7) we have:

Piezoelectric coefficient (when applying forces perpendicular to the sensor plane).- $d33 = 24 \text{ pC/N}$

Dielectric constant.- $\epsilon = 1,1 \cdot 10^{-10} \text{ F/m}$;

Elasticity modulus of the PVDF.- $E = 2000 \text{ MPa}$

Effective sensor area.- $L \cdot L2 = 4 \cdot 10^{-4} \text{ m}^2$

Sensor thickness.- $40 \mu\text{m}$

Oscilloscope input resistance.- $R = 10 \text{ M}\Omega$

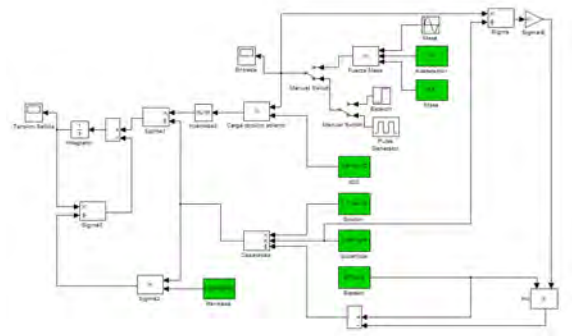

Figure 4: Simulink model for simulating piezoelectric polymer behaviour.

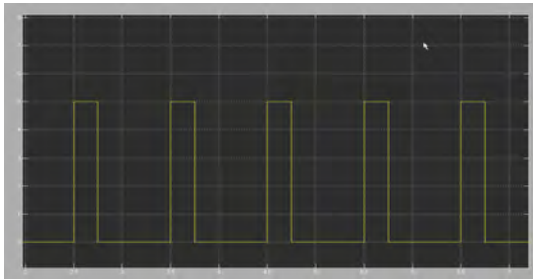

Figure 5: Simulation of levels of pressure as simulator input.

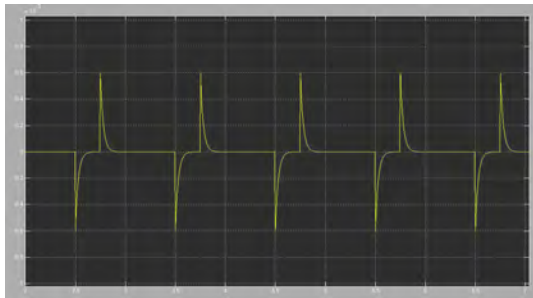

Figure 6: Output obtained (voltage) according to the simulation.



Figure 7: First trials: The oscilloscope shows sensor output voltage on applying levels of pressure as input.

3 MANUFACTURING THE DEVICE FOR DIAGNOSING BRUXISM

To obtain the instrumented splint some of the steps followed in the manufacture of thermoformed splints are followed. A model of the patient’s teeth needs to be made, usually by shape copying. This model is put into a vacuum thermoforming machine in which a polymer wafer heated to a temperature higher than its softening temperature covers the model and reproduces the teeth geometry when a vacuum is applied on cooling.

The piezoelectric sensors are then placed on this first thermoformed layer and the operation is repeated with a second polymer wafer, whereupon

the sensors become embedded within the two layers. It is important to control the thermoforming temperature since piezoelectric polymers used as sensors begin to lose their electromechanical coupling at temperatures above 80 °C.

Finally the excess parts are trimmed off and the splint is subjected to an adjustment and polishing process to adapt it to the patient. In this way a splint is obtained like the one shown below in Figure 8, which enables interdental pressures to be detected for the purpose of diagnosing bruxism.



Figure 8: Splint with piezoelectric sensors for diagnosing bruxism.

4 FIRST “IN VITRO” AND “IN VIVO” TRIALS

4.1 “In Vitro” Trials

To simulate biting in “in vitro” trials, a pneumatically operated system was constructed in which moulds could be placed that reproduce patients’ teeth, and on which the instrumented splints could be placed. The pneumatic system’s actuators allow both perpendicular and transversal bruxism to be simulated with operating pressures of up to 6 bar in the pneumatic actuators providing bite forces of 750 N. This is shown in Figure 9.



Figure 9: Bruxism simulator with pneumatic operation for the “in vitro” trials.

To carry out the “in vitro” trials moulds of the teeth of 3 patients taking part in the research were done. Resin reproductions of these teeth were made as a support for manufacturing the splints, which could also be placed in the bite simulator to artificially operate these instrumented splints.

Figures 10 and 11 show the response of the instrumented splints on being placed in the bite simulator and subjected to pneumatic operation. The connectors coming from the splint attached to the sensors were connected to a charge amplifier and an analogical-digital converter. This system’s output was recorded using a data acquisition card commercially available known as “Measurement Computing USB 1208-FS”.

The response to prolonged 10-second bites was studied for with 10-second relaxation between bites. The sensor response capacity and that of the A/D amplifier-converter system were also assessed, with successive bite episodes of different frequencies.

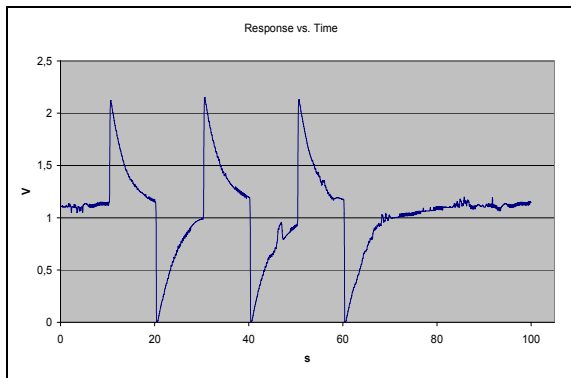

Figure 10: Simulation of 3 successive bites: Operation at 1 bar \approx 150 N of bite during 10 s and relaxation during another 10 s.

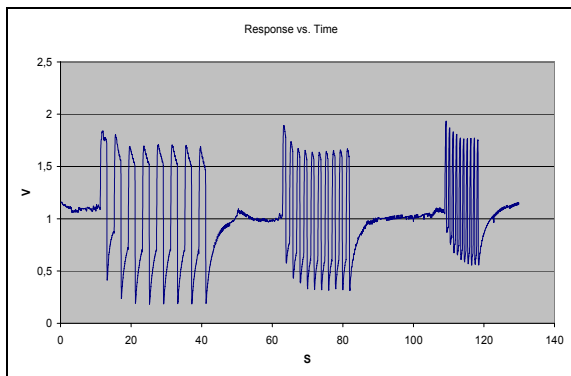

Figure 11: Simulation of successive bite episodes (operation at 1 bar \approx 150 N of bite): First episode.- 8 bites with 2 s clenching and relaxation time. Second episode.- 10 bites with 1 s clenching and relaxation time. Third episode.- 10 bites with 0.2 s clenching and relaxation time.

After a positive assessment of the properties of the intrabucal pressure detection system and signal adjustment, processing and recording, “in vivo” trials were carried out, the results of which are presented below.

4.2 “In Vivo” Trials

The splints used for the previous trials were used again with the 3 patients taking part in the research for the first “in vivo” trials. They enabled the response of splints in actual mouths to be assessed and their resistance and duration to be tested, as well as their water-tightness to avoid any deterioration of the sensors. The responses recorded both of sudden and prolonged bites are shown in Figures 12 and 13.

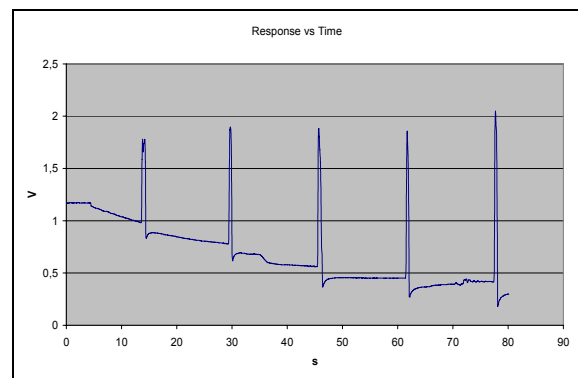

Figure 12: Output voltage in response to bite impacts every 15 seconds.

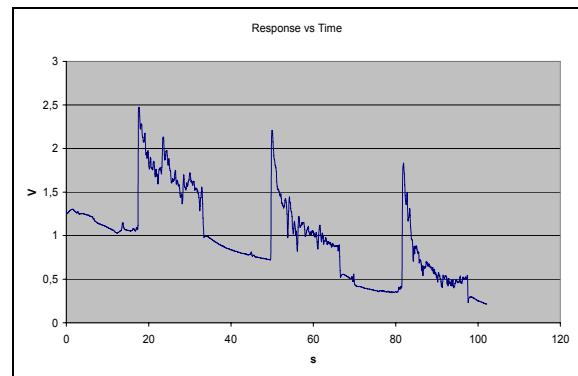

Figure 13: Output voltage with prolonged bites every 15 seconds and 15 seconds of relaxation.

The results of the trials carried out with the patients’ splints show that it is possible to detect bruxism episodes of different intensities and duration which, combined with the ability to record and store the data, converts the system into a “Holter” for diagnosing bruxism and evaluating intrabucal pressures.

5 RESULTS ASSESSMENT AND FUTURE ACTIONS

The complete development of a splint to assess intrabuccal pressure and diagnose bruxism and other occlusive pathologies has been presented. The system stands out for its use of polymeric piezoelectric sensors which, on account of their reduced size, do not produce any alterations to the patient's bite. The design process, modelling, simulation, manufacture and first trials have been described in detail, both in the pneumatic simulator and in 3 patients taking part in the research.

Currently, additional trials are being carried out with a total of 15 patients, with similar results to those shown in Figure 7. The electronics used (analogical-digital converter module and charge amplifier) need to be improved in order to optimise system response. The results of the "in vivo" trials are being compared with the behaviour models set out in order to improve control over the factors influencing the diagnosis of bruxism using instrumented splints.

However, what should be highlighted is the possibility to obtain a device that will enable intrabuccal pressure to be quantitatively assessed and bruxism behaviour to be diagnosed at an early stage, so that corrective actions can be programmed before the appearance of irreversible dental wear. The first "in vitro" simulations and "in vivo" trials carried out serve to demonstrate the feasibility of the system in accordance with the initial objectives.

This work was partial result of "FEMAB Project: Micro-instrumented Anti-bruxism Splint" subsidised by the Spanish Ministry of Education and Science with Reference PROFIT (Promotion of Technical Research) CIT-020400-2005-17. It has been carried out in collaboration between Universidad Politécnica de Madrid and Ibex Estética Dental S.L..

REFERENCES

- S. Ashley, *Artificial Muscles*. Scientific American 2003.
- Y. Bar-Cohen, *Electroactive Polymer (EAP) Actuators as Artificial Muscles*. SPIE Press, Second Edition. Washington 2004.
- Y. Bar-Cohen, et al. *Characterization of the Electromechanical Properties of EAP Materials*. Jet Propulsion Laboratory (JPL)/Caltech. SPIE. Newport, CA, 2001.
- P. Dubois, et al., *Microactuators based on ion-implanted dielectric electroactive polymer membranes (EAP)*. Microsystems for Space Technologies Laboratory, Lausanne. IEEE Transducers 2005.
- M. Hafez, *Course on Polymer Based Actuators as Artificial Muscles*. FSRM (Swiss Foundation for Research in Microtechnology). Zurich 2006.
- G. Lavigne et al., *Bruxism: Epidemiology, diagnosis, patho-physiology and pharmacology*. Advances in pain research and treatment 1995.
- G. Lavigne et al., *Neurobiological mechanisms involved in sleep bruxism*. Faculté de Médecine, Université de Montréal 2003.
- G. Lavigne et al., *Sleep bruxism: validity of clinical research diagnostic criteria in a controlled polysomnographic study*. Journal of Dental Research 1996.
- Measurement Specialties, Inc., *Piezo Film Sensors Technical Manual*. Sensor Products Division 1999.
- K. Nishigawa, et al., *Quantitative study of bite force during sleep associated bruxism*. Journal of Oral Rehabilitation 2001.
- D. Cosme, et al., *Bruxism and voluntary maximal bite force in young dentate adults*. The International Journal of Prosthodontics 2005.
- K. Baba, *Bruxism force detection by a piezoelectric film-based recording device in sleeping humans*. Journal of Orofacial Pain 2003.